

CTP32-Rotate

32 channel telemetry for rotating applications like wheels or rotors, high signal bandwidth, 16bit, software programmable



- Inputs for STG, POT, TH-K, ICP, VOLT ..
- Simultaneous sampling
- 16 bit resolution
- Software programmable
- Signal bandwidth: 32 x 0-3000Hz
- Battery power up to 6h
- Radio telemetry transmission
- Output analog +/- 10V
- Digital data interface to PC (option)
- Waterproofed ENC housing (IP65)

General functions:



The CTP32-Rotate is a 32-channel telemetry system for rotating applications with integrated signal conditioning for sensor signals, wireless digital transmission and analog reproduction.

In the encoder/transmitter unit the sensor signals are conditioned, filtered (anti-aliasing) and digitized (16-bit). Simultaneous sampling is provided for all channels. Finally, the PCM encoded data is transmitted via radio frequencies to the receiver.

Various configurations of different sensor modules are available incl. signal conditioning for strain gages (STG), thermocouples type K (TH-K), ICP sensors, potentiometer sensors (POT) and also voltage inputs. Mixed configuration available (2-CH-steps).

All sensor modules are software programmable via LAN-Adapter. The LAN-Adapter has an integrated web interface and enables easy access!

The stationary receiver provides 32 +/-10V analog outputs via Sub-D male socket (option: digital PC interface).

The analog signal bandwidth is 0-190 Hz (320kbit) and up to 0-3000Hz (5000kbit) for 32 channels. The measurement accuracy is $\leq \pm 0.2\%$ (without sensor). The CTP32-Rotate is specified for operational temperatures from -20°C to $+70^{\circ}\text{C}$. The maximum distance between transmitter and receiving antenna is approx. 10-20 m (30-60 feet) – depending on the application! Mixed configuration available (2-CH-steps).

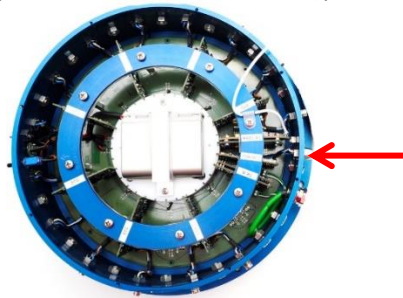

Specify CTP-acquisition modules at order!!

Frequency table	Cut off frequency from anti-aliasing filter (-3dB) and sampling rate (see red)
Bit rate	32 CH.
5000kbit	3000 Hz (7812.50Hz)
2500kbit	1500 Hz (3906.25 Hz)
1250kbit	750 Hz (1953.125 Hz)
625kbit	375 Hz (976.56 Hz)
312.5kbit	190 Hz (488.28 Hz)

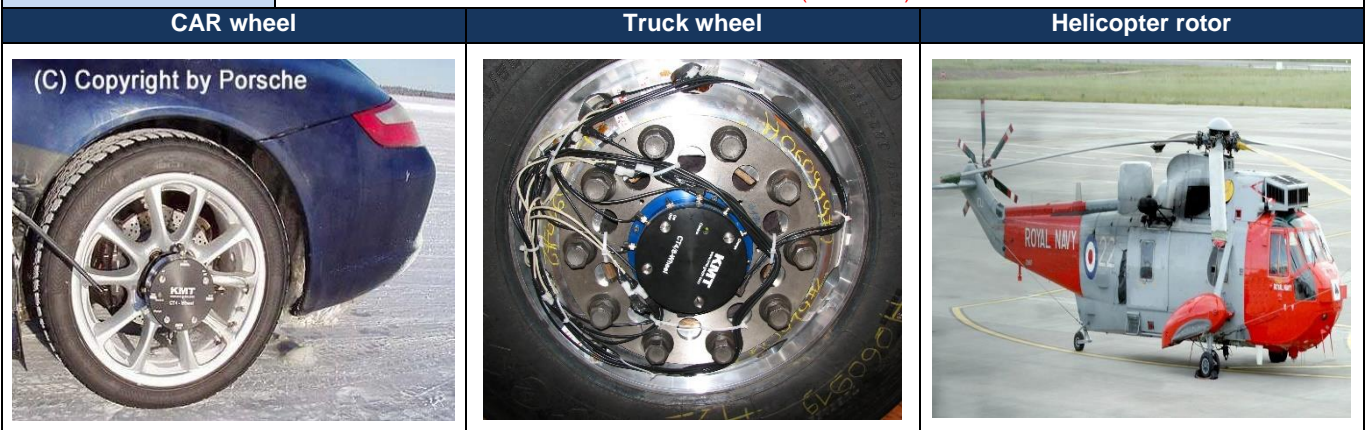

CTP32-Rotate Transmitting Unit Technical Data (Encoder)



Encoder in IP65 Aluminum housing

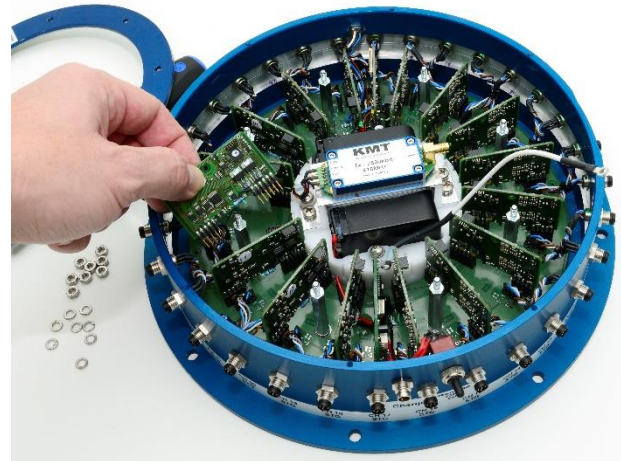

Encoder inside

CTP acquisition modules (rotor side)

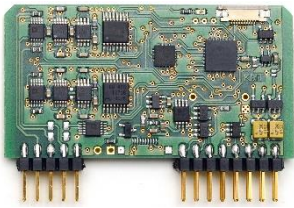

CTP-STG V3
 Acquisition module for 2 strain gages
 Full, half and quarter bridge ($\geq 350\Omega$)
 Fixed excitation 4V DC
 Offset calibration by auto zero
 Gain: 125-250-500-1000-2000
 Signal bandwidth 0 Hz to 3000Hz*
 (*see table of cut-off-frequency)
 Resolution 16bit
 Accuracy <0.2%
 Current consumption with full bridge 350 ohm 75mA

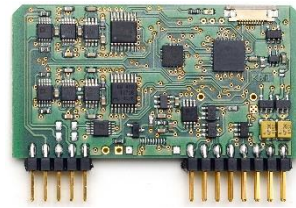

CTP-VOLT V3
 Acquisition module for 2x high level inputs
 Range: $\pm 0,625V, \pm 1,25V, \pm 2,5V, \pm 5V, \pm 10V$
 Signal bandwidth 0 Hz to 3000Hz*
 (*see table of cut-off-frequency)
 Resolution 16bit
 Accuracy <0.2%
 Current consumption 60mA

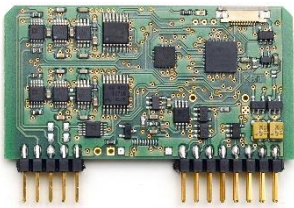

CTP-ICP V3
 Acquisition module for 2 ICP sensors
 Current EXC. 4mA
 Gain: 1-2-4-8-16-32
 Signal bandwidth 3 Hz to 3000Hz*
 (*see table of cut-off-frequency)
 Resolution 16bit
 Accuracy <0.2%
 Current consumption 100mA

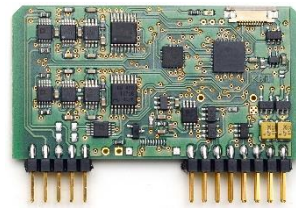

CTP-TH-K V3
 Acquisition module for 2x TH-K inputs galvanic isolated
 Range -50 to 1000°C, -50 to 500°C or -50 to 250°C
 Cut-off filter 30Hz (more on request)
 Resolution 16bit
 Accuracy: 0.2% at 1000°C range
 Current consumption 110mA

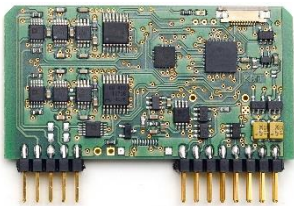

CTP-POT V3
 Acquisition module for 2 poti-sensors with $\geq 350\Omega \dots 10k\Omega$ (typical 1k Ω)
 Fixed excitation 4V DC
 Signal bandwidth 0 Hz to 3000Hz*
 (*see table of cut-off-frequency)
 Resolution 16bit
 Accuracy <0.2%
 Current consumption about 70mA

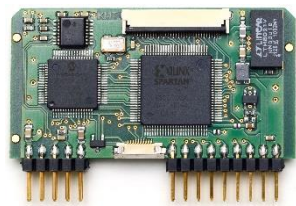

CTP-CONTROL V3
 Controller 1- 32 acquisition modules
 Output: PCM
 Programmable via LAN adapter
 Current consumption 40mA, with LAN-adapter 140mA

System Parameters ENCODER:

Channels:	32
Resolution:	16 bit A/D converter with anti-aliasing filter, simultaneous sampling of all channels
Line-of-sight distance:	up to 20m (depends of application and bit rate)
Powering:	Li Ion Accumulator 7.2V, 7800mA capacity up to 6 hours
Power consumption:	about 1300mA using 32x STG full bridge sensors 350 Ohms
Analog signal bandwidth:	See table
Transmission:	Digital PCM Miller format - FSK
Transmission Power:	10mW
Dimensions:	Diameter 250mm, bottom plate diameter 280mm, height 80mm (without antenna), 160 with antenna!
Weight:	3.60 kg without sensor cables and antenna
Operating temperature:	- 20 ... +70°C
Housing:	Aluminum anodized, waterproofed (IP65)
Humidity:	20 ... 80% no condensing
Vibration:	5g Mil Standard 810C, Curve C
Static acceleration:	100g in all directions, 1000 RPM
Shock:	200g in all directions

Technical specifications are subject to change without notice!

CTP-DEC32 Receiver unit for max 32 Channels output via 37 pol. Sub D (radio transmission version via **quad** receiver 1250 and 5000kbit)

Front side view

Female 37 pole Sub-D for analog signal output, CH 1 to 32



Rear side view

CTP - DEC32

Low Pwr LED ON = BATT empty!

Power ON LED

Power Switch

Transmission error LED
Fuse of powering defect LED

7-pole female TUCHEL connector for power supply input (10-30V DC)

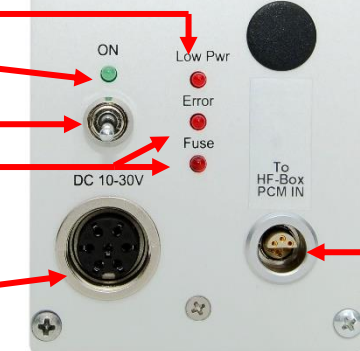

PCM IN coming from HF-BOX

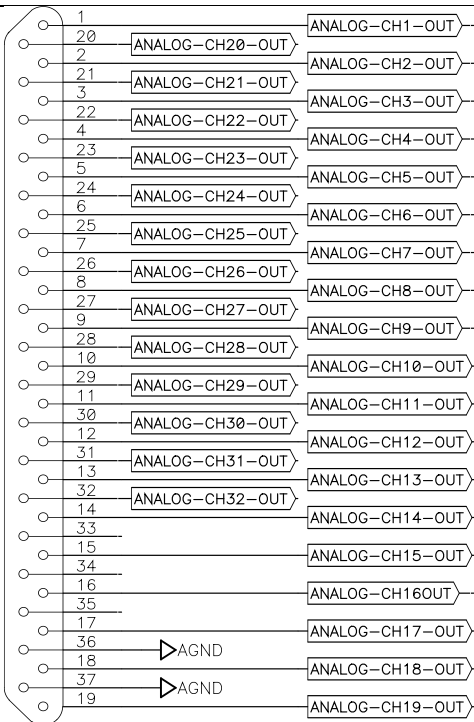

Plug-side

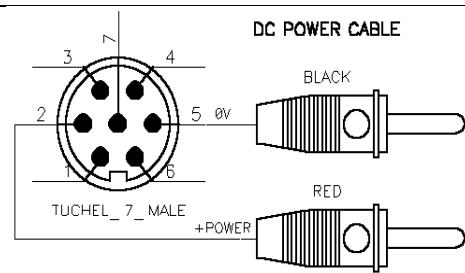

Optional BNC32Box. Connect on 37pol Sub-D

CTP-DEC32 System Parameters:

Channels:	32 x +/-10V analog outputs via Sub-D male socket
Resolution:	16 bit D/A converter, with smoothing filter
Power supply input:	10-30 VDC, power consumption <24 Watt
Analog signal bandwidth:	see frequency table
Transmission:	Digital PCM Format
Dimensions:	205 x 105 x 65mm
Weight:	1.00kg without cables and antenna
Overall system accuracy between encoder input and decoder output:	+/-0.2% without sensor influences
Environmental	
Operating:	-20 ... +70°C
Humidity:	20 ... 80% not condensing
Vibration:	5g
Static acceleration:	10g in all directions
Shock:	100g in all directions

CTP-DEC32 Receiver unit for max 32 Channels output via 37 pol. Sub D (radio transmission version with HF BOX Quad with 4 receiver 1250-5000kbit)

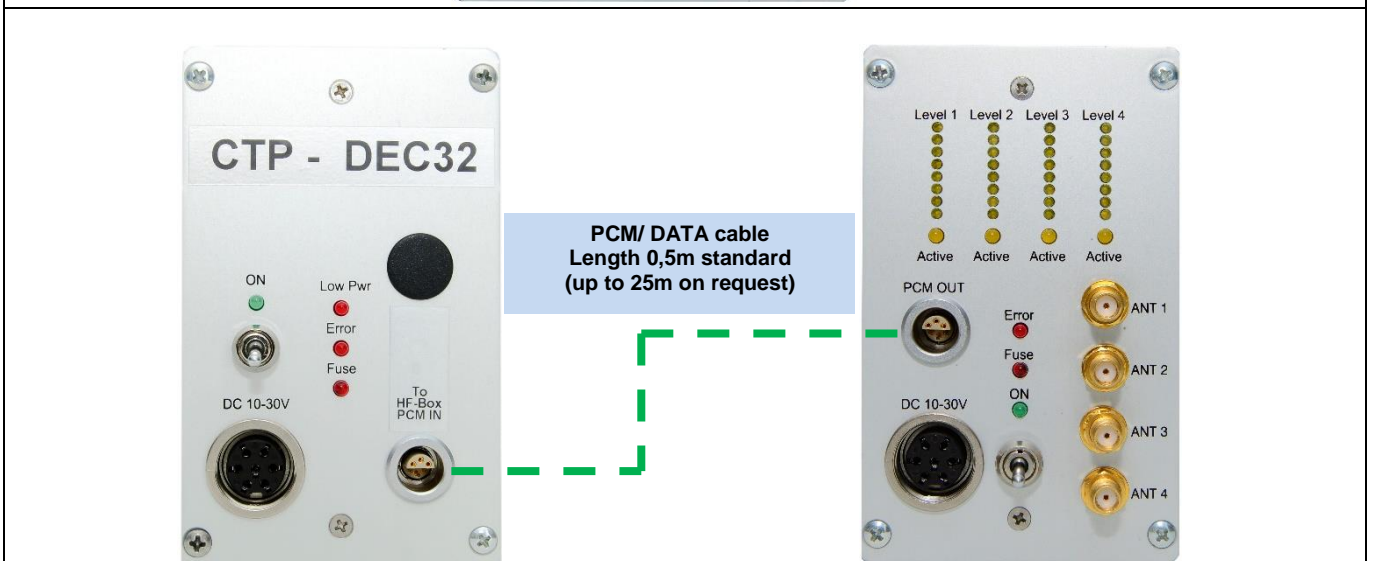
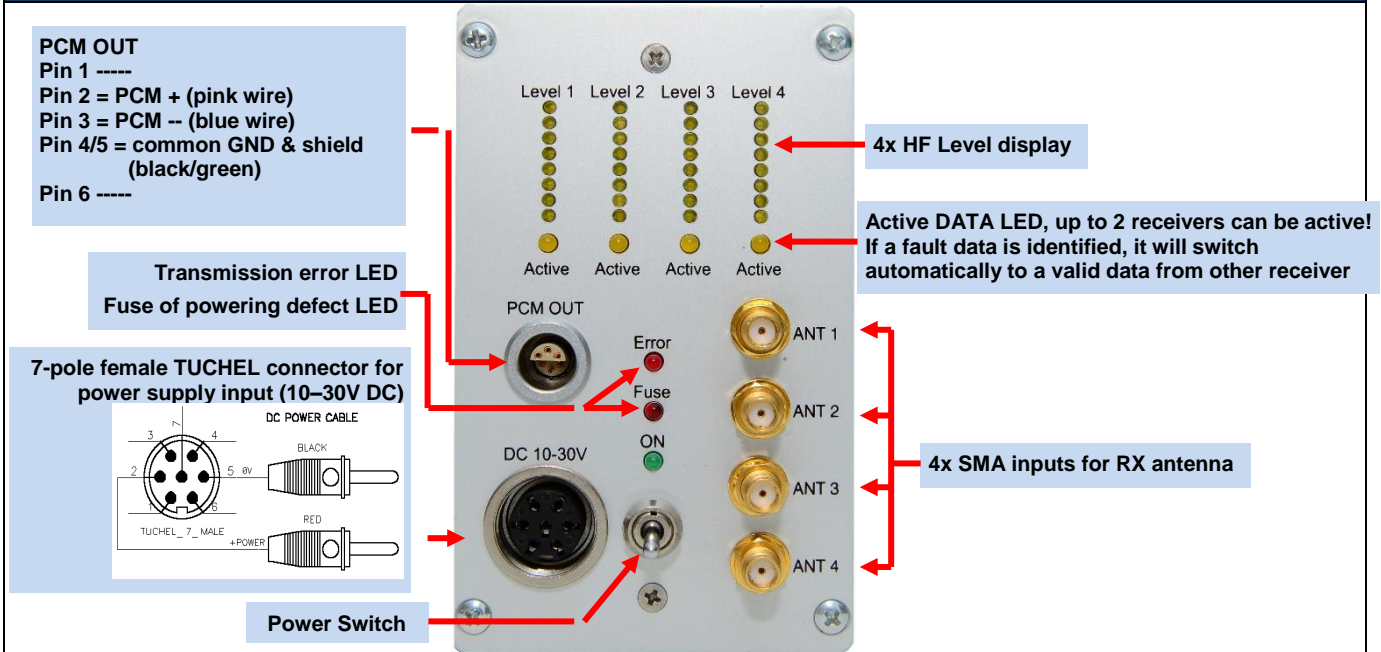

HF BOX Quad System Parameters:

HF receivers	4
Antenna connection	SMA
Output	PCM
Power supply input:	10-30 VDC, power consumption <24 Watt
Dimensions:	205 x 105 x 65mm
Weight:	1.050 kg without cables and antenna
Environmental	
Operating:	-20 ... +70°C
Humidity:	20 ... 80% not condensing
Vibration:	5g
Static acceleration:	10g in all directions
Shock:	100g in all directions

Settings CTP-Rotate-ENC

Web interface address LAN adapter:
e.g. IP 192.168.0.110 or 111, 112
 (see current IP no. on LAN-Adapter!!)

Settings:

STG

Gain 125-250-500-1000-2000
 Half- and full bridge
 Make Auto Zero YES/NO

ICP

Gain 1-2-4-8-16

VOLT

Range $\pm 0,625V$, $\pm 1,25V$, $\pm 2,5V$,
 $\pm 5V$, $\pm 10V$

TH-K

Range -50 to 1000°C, -50 to 500°C
 or -50 to 250°C

PT100/1000

Type:	PT100	4 Wire
	PT100	3 Wire
	PT100	2 Wire
	PT1000	4 Wire
	PT1000	3 Wire
	PT1000	2 Wire

Range: -25..150 °C
 -50..300 °C
 -100..600 °C

Selectable for each channel!

Programmable via web interface

Channel 1 Strain Gauge Type: FULL-BRIDGE Gain: 1000 Make Autozero: Channel 1

Channel 2 Strain Gauge Type: FULL-BRIDGE Gain: 1000 Make Autozero: Channel 2

Channel 3 Strain Gauge Type: FULL-BRIDGE Gain: 1000 Make Autozero: Channel 3

Channel 4 Strain Gauge Type: FULL-BRIDGE Gain: 1000 Make Autozero: Channel 4

Channel 5 Strain Gauge Type: FULL-BRIDGE Gain: 1000 Make Autozero: Channel 5

Channel 6 Strain Gauge Type: FULL-BRIDGE Gain: 1000 Make Autozero: Channel 6

Channel 7 Strain Gauge Type: FULL-BRIDGE Gain: 1000 Make Autozero: Channel 7

Channel 8 Strain Gauge Type: FULL-BRIDGE Gain: 1000 Make Autozero: Channel 8

Channel 9 Strain Gauge Type: FULL-BRIDGE Gain: 1000 Make Autozero: Channel 9

Channel 10 Strain Gauge Type: FULL-BRIDGE Gain: 1000 Make Autozero: Channel 10

Channel 11 Strain Gauge Type: FULL-BRIDGE Gain: 1000 Make Autozero: Channel 11

Channel 12 Strain Gauge Type: FULL-BRIDGE Gain: 1000 Make Autozero: Channel 12

Channel 13 Strain Gauge Type: FULL-BRIDGE Gain: 1000 Make Autozero: Channel 13

Channel 14 Strain Gauge Type: FULL-BRIDGE Gain: 1000 Make Autozero: Channel 14

Channel 15 Strain Gauge Type: FULL-BRIDGE Gain: 1000 Make Autozero: Channel 15

Channel 16 Strain Gauge Type: FULL-BRIDGE Gain: 1000 Make Autozero: Channel 16

Channel 17 Strain Gauge Type: FULL-BRIDGE Gain: 1000 Make Autozero: Channel 17

Channel 18 Strain Gauge Type: FULL-BRIDGE Gain: 1000 Make Autozero: Channel 18

Channel 19 Strain Gauge Type: FULL-BRIDGE Gain: 1000 Make Autozero: Channel 19

Channel 20 Strain Gauge Type: FULL-BRIDGE Gain: 1000 Make Autozero: Channel 20

Channel 21 Strain Gauge Type: FULL-BRIDGE Gain: 1000 Make Autozero: Channel 21

Channel 22 Strain Gauge Type: FULL-BRIDGE Gain: 1000 Make Autozero: Channel 22

Channel 23 Strain Gauge Type: FULL-BRIDGE Gain: 1000 Make Autozero: Channel 23

Channel 24 Strain Gauge Type: FULL-BRIDGE Gain: 1000 Make Autozero: Channel 24

Channel 25 Strain Gauge Type: FULL-BRIDGE Gain: 1000 Make Autozero: Channel 25

Channel 26 Strain Gauge Type: FULL-BRIDGE Gain: 1000 Make Autozero: Channel 26

Channel 27 Strain Gauge Type: FULL-BRIDGE Gain: 1000 Make Autozero: Channel 27

Channel 28 Strain Gauge Type: FULL-BRIDGE Gain: 1000 Make Autozero: Channel 28

Channel 29 ICP Gain: 1 Channel 29

Channel 30 ICP Gain: 1 Channel 30

Channel 31 ICP Gain: 1 Channel 31

Channel 32 ICP Gain: 1 Channel 32

Upload Parameters to MT-PRO and perform Autozero

Download Parameters from MT-PRO ***** Download success *****

KMT Kraus Messtechnik GmbH
 Gewerbering 9
 D-83624 OTTERFING
 Germany
www.kmt-gmbh.com
info@kmt-gmbh.com